

DVR 1020HD Digital Camcorder

User Manual



Vivitar®

© 2009-2011 Sakar International, Inc. All rights reserved.

Windows and the Windows logo are registered trademarks of Microsoft Corporation.

All other trademarks are the property of their respective companies.

Contents

Introduction	2
What's Included	2
Camera Technical Specifications	3
Computer System Requirements – Windows.....	4
Computer System Requirements – Macintosh.....	4
Parts of the Camera.....	5
Initial Camera Setup	6
Powering ON/OFF Your Digital Video Camera.....	9
Changing Camera Mode.....	9
Navigating the Menus	10
Video Capture Mode	11
Video Playback Mode	23
Photo Capture Mode.....	28
Photo Playback Mode	44
Connecting the Digital Video Camera to a TV.....	49
Installing the Software.....	50
Connecting the Camera to the Computer	51
Getting Photos and Videos from Your Camera to Your Computer.....	52
Get started!	53
Transferring Images from My Camera to My Computer Manually.....	53
Camera Maintenance.....	54
Sakar Warranty Card	55
Technical Support	56
Troubleshooting	56

Introduction

Thank you for purchasing this digital video camera. Everything you need to take quality digital photos and videos is included with your digital video camera.

Vivitar makes capturing those special moments as easy as possible.

Note: Your digital video camera needs an SD Memory card (up to 32GB) for normal use. SD Memory cards are not included and need to be purchased separately.

It is recommended to use an SDHC Class 4 **4** SD card or higher.

Please read this manual carefully first in order to get the most out of your digital video camera.

What's Included

- 1) Digital Camcorder
- 2) USB Cable
- 3) AV Cable
- 4) Vivitar Experience Image Manager Software
Installation CD
- 5) Hand Strap (not shown)



Note: SDHC Class 4 (or higher) Memory card and batteries not included.

Camera Technical Specifications

Image Sensor	CMOS Sensor
Image Resolution	3264x2448 (8M), 2592x1944(5M) / 2048x1536(3M) / 1600x1200(2M) / 1280x1024(1M) / 640x480(VGA)
Video Resolution	1920x1080 (FHD), 1280x720 (HD), 848x480 (D1), VGA 640x480 (640), QVGA 320x240 (320)
File Format	JPEG/AVI
External Memory	SDHC Card (up to 32GB)
LCD Display	2.7 Inch TFT
Zoom	4X Digital Zoom
Exposure	-3.0EV ~ +3.0EV
White Balance	Auto, Daylight, Cloudy, Incandescent , Fluorescent
ISO	Auto / 100 / 200 / 400
Scene	Auto, Scenery, Portrait, Night Scenery, Night Portrait, Sport, Beach, Party
Language	English, French, Spanish, Portuguese, German, Dutch, Italian, Turkish
Flash	LED Flash lamp
Self-Timer	2, 5 or 10 second delay
Multi Shot	Yes
Anti-Shake	Yes
Face Detect	Yes
Smile Capture	Yes
Print Photos	Yes
Interface	USB 2.0
System Requirements	Windows XP (SP 3), Vista (SP1) and 7; Mac OSX v10.5.x and above
Battery	3 x AA Batteries (Alkaline batteries recommended)
Working Temperature	0~40°C

Computer System Requirements – Windows

To be able to download photos and videos to your PC, you will need the following minimum configuration:

- Microsoft® Windows XP with Service Pack 3, Windows Vista with Service Pack 1 or Windows 7
- Pentium® 4 processor (or above)
- 512 MB of RAM, with 250 MB of free hard disk space
- 16-bit Color monitor, 1024 X 768 recommended screen resolution
- CD-ROM Drive
- QuickTime® 6 or higher
- Microsoft® Internet Explorer 7 or higher
- Windows Media Player 10 or higher
- DirectX 9 or higher
- Internet connection required

Computer System Requirements – Macintosh

To be able to download photos and videos to your Macintosh, you will need the following minimum configuration:

- Intel processor running Mac OS X v10.5.x or later
- 256 MB RAM, 250 MB free hard disk space
- Display: 1024 x 768 or higher-resolution monitor
- QuickTime® 6 or higher
- Internet connection required

Parts of the Camera

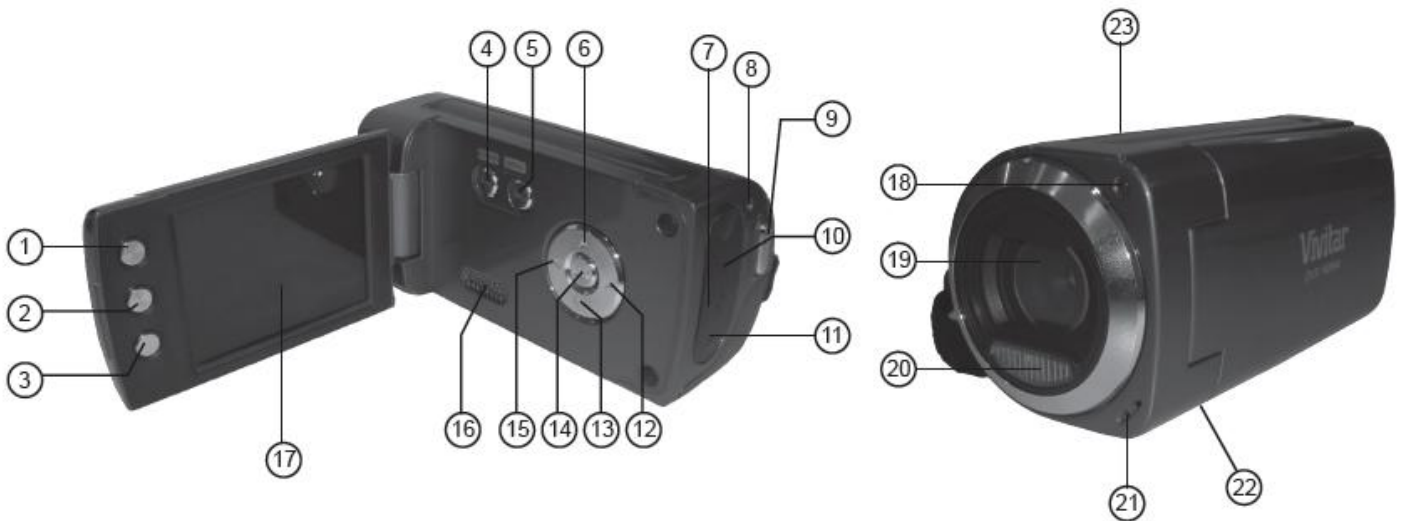

- | | |
|-------------------------------|------------------------------|
| 1. Display Button | 13. Down / Zoom Out Button |
| 2. Delete Button | 14. OK Button |
| 3. MODE Button | 15. Left / ViviLink Button |
| 4. POWER Button | 16. Speaker |
| 5. MENU Button | 17. LCD Screen |
| 6. Up / Zoom In Button | 18. Self-Timer LED Indicator |
| 7. USB Port | 19. Digital Lens |
| 8. Busy LED Indicator | 20. LED Light |
| 9. Shutter Button | 21. Microphone |
| 10. SD Memory Card Slot | 22. Tripod Mount |
| 11. AV Out Port | 23. Battery Compartment |
| 12. Right / LED On-Off Button | |

Initial Camera Setup

Installing the Batteries



- Insert 3 x AA batteries as shown above. Alkaline batteries recommended (not included).

Installing the Memory Card



- SD Memory card (up to 32GB) needed for normal use.
- SDHC Class 4 (or higher) recommended (not included).

Turning On the Camera



Using the Camera

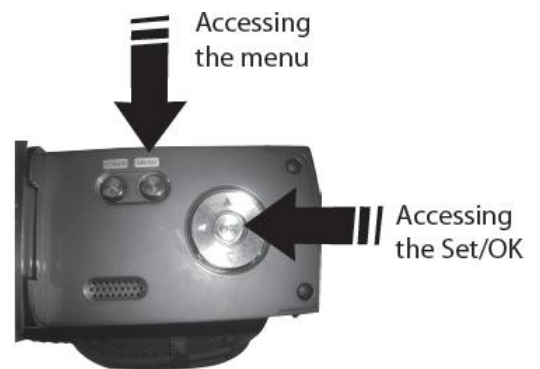

When powering the camera ON **for the first time** the camera will take you through the initial camera setup.

Powering the Camera ON

1) Installing the Batteries

Make sure the batteries have been inserted properly into your digital camera, according to the polarity shown inside the battery compartment.

Use 3 x AA (1.5V) batteries. Alkaline batteries are recommended. Batteries not included.

Note:

- Remove the batteries from the camera when not in use for an extended period.
- Do not mix alkaline and non-alkaline batteries.
- Some features, such as Flash (if included with your camera), will not work if the battery power level is low.
- When the battery power is low the battery icon turns red and the camera will automatically turn off a few seconds later.
- The energy status of the power is displayed on LCD as shown below:

 *Full battery power*  *Medium battery power*  *Low battery power*

2) Installing the SD Memory Card

Open the SD cover to reveal the SD Memory card slot.

Make sure a Memory Card (up to 32GB, Class 4 (or higher) SDHC recommended) has been properly inserted into your camera. SD card not included.

To properly insert the SD Card:

- Press the SD card into the slot in the direction shown on the SD icon located on the cover of the SD slot.
- Press the SD card until you hear a slight clicking sound. This indicates the SD card has been inserted correctly.

Note:

- After the camera is powered on, an SD icon will appear on the LCD display. If you do not see the SD icon on the display, please check if the card was inserted properly.
- Make sure the SD card is not locked (check the lock switch on the side of the SD card).
If the SD card is locked this will prevent the camera from saving captured images to the SD card.

3) Powering ON the camera

Press the **POWER**  button to turn on the camera.

Setting the Camera Language

- 1) You will first be prompted to select a language for the camera.
- 2) The Language selection menu will appear.
- 3) Press the **Up** and **Down** buttons to select the language of your choice and press the **OK** button to confirm the selection.

Setting the Date and Time

The next step in the initial camera setup is to set the date and time on the camera.

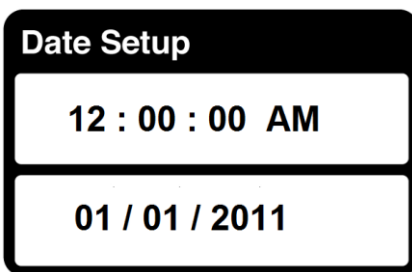

- 1) Set the Date and Time as desired by pressing the **UP** and **DOWN** buttons to change the setting and the **Right** and **Left** buttons to move to the next setting option.
- 2) Press the **OK** button to confirm the selection.

Your camera is now ready to use.

Powering ON/OFF Your Digital Video Camera

- Make sure the batteries have been inserted properly into your digital camera.
If your camera uses a rechargeable lithium battery, make sure the battery is fully charged.
- Make sure an SDHC card has been inserted into your camera.
(SDHC card up to 32GB - SD Card not included)

Powering the camera ON

Press the **Power** button  to turn your camera ON. The camera will be in Video Capture mode to start.

Powering the camera OFF

While the camera is on, you can press the **Power** button  again at any point to turn your camera OFF. You will see a “Goodbye” splash screen and then the camera will power off completely.

Note: Your digital video camera also has an Auto Power Off feature that will automatically turn off your camera after a specific period of time that your camera is left idle. The Auto Power Off settings can be set from the Auto Power Off settings menu.

Changing Camera Mode

Your camera has three main modes:

- 1) **Video Capture Mode** - Use this mode to capture videos with your camera.
- 2) **Photo Capture Mode** - Use this mode to capture photos with your camera.
- 3) **Playback Mode (for photos and videos)** - Use this mode to view the photos and videos you have already taken with your camera.

When the camera is first powered ON, the Video Capture Mode will be active. The icons that appear on the LCD screen are the best default settings so that you can begin to capture and enjoy clear quality photos.

To change the active camera mode, make sure the camera is powered ON and press the **MODE** button.

 When in Video Capture Mode, this icon will display on the top-left corner of the LCD display

 When in Photo Capture Mode, this icon will display on the top-left corner of the LCD display

 When in Playback Mode, this icon will display on the top-left corner of the LCD display

Navigating the Menus

Each camera mode has a set of menus specific to that mode.



- 1) Press the **MENU** button to open the menus for the current mode.
- 2) Press the **LEFT** or **RIGHT** button to scroll between the various menus for the current mode.
- 3) Press the **UP** or **DOWN** button to highlight the desired menu selection.
- 4) Press the **OK** button to confirm and select the highlighted menu option.
- 5) If the selection can be remembered by the camera, a selection icon  will appear to the right of the selected menu option. Changes made to these options will remain as is until you decide to change them again at a later time.
- 6) Some menu options are single-use functions that are not remembered by the camera and do not display this icon when selected.
- 7) At any time you can press the **MENU** button to exit the menus and return to the previous screen.

Video Capture Mode

The Video Capture Mode allows you to capture videos with your digital video camera.





When the camera is first powered ON, the camera will be in Video Capture Mode.

Taking a Video

- 1) While in Video Capture Mode use the LCD display to direct your digital video recorder at the scene you would like to capture.
- 2) Press the  **UP/Zoom In** and  **DOWN/Zoom Out** buttons to better set the camera display if desired.
- 3) Press the **RIGHT/LED ON-OFF** button to turn on the LED light. This helps to better illuminate the area you would like to capture on video.
- 4) Press the **Shutter** button to start the video capture.
- 5) A blinking red circle appears at the top of the LCD indicating that the record is in progress.
The elapsed recording time is shown on the top right corner of the LCD screen.
- 6) To stop the video recording, press the **Shutter** button again.
- 7) The video will automatically be saved to the camera's SD memory card.

Video Capture Mode Quick Function Buttons

Your digital video camera has a four-directional control button that functions as Quick Function buttons.

Quick Function Button	Function
 Left	ViviLink - Opens the ViviLink for Videos menu
 Up	Zooms In
 Right	Turns on and off the LED light
 Down	Zooms out

Other

Shutter	STARTS/STOPS the video capture
 Delete	Delete Image - Opens the Delete Menu with the option to delete the last captured image (video or photo) or to delete all, unlocked

	captured images
MENU	<ul style="list-style-type: none"> - Opens the menu options for Video Capture Mode - Exits the menu screen - Note: Use the LEFT/RIGHT/UP/DOWN buttons to navigate the menus.
OK	Saves your selected option in the Menu view
MODE	Toggles between the Video Capture Mode, Photo Capture Mode, and Playback Mode
DISPLAY	Hides or shows the display icons on the LCD screen

Video Capture Mode Menus

The following are the menus that appear in your camera's Video Capture Mode:

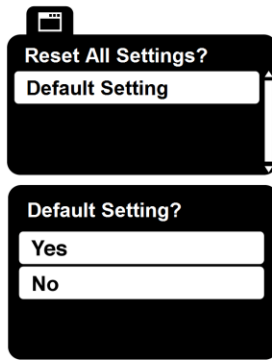
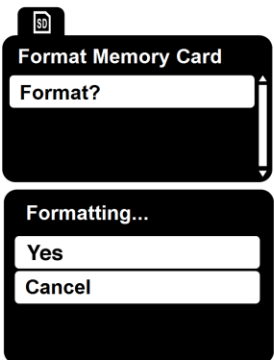
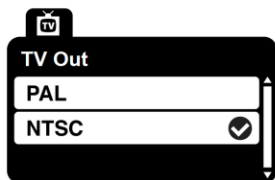
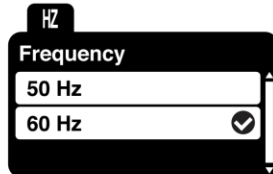
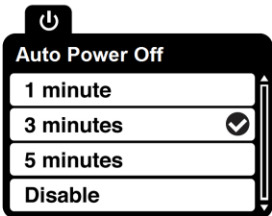
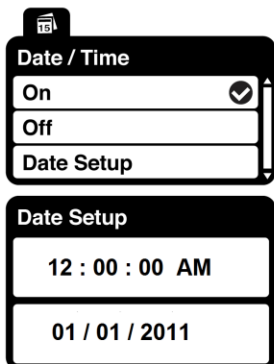
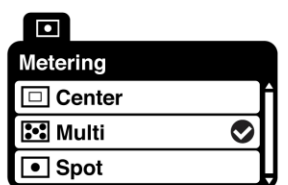
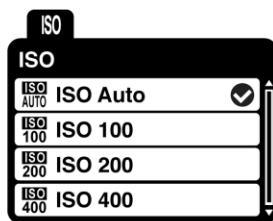
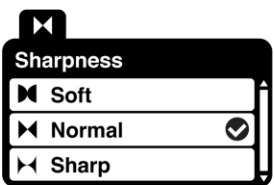
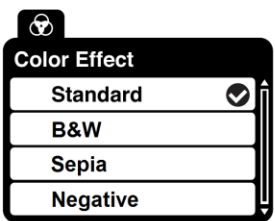
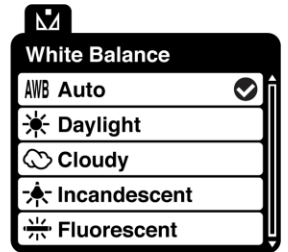
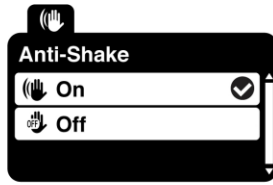
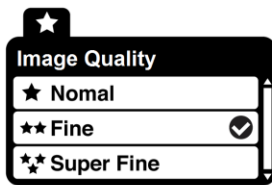
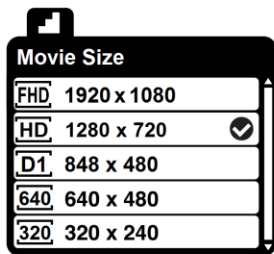

Scene Menu

The Scene Menu allows you to choose scene settings that let your camera to adapt properly to your current environment.

- 1) Press the **MENU** button to open the menus for the current mode.
- 2) Press the direction button **LEFT** or **RIGHT** to scroll and select the Scene menu.
- 3) Press the direction button **UP** or **DOWN** to highlight the desired menu selection.
- 4) Press the **OK** button to confirm and select the highlighted menu option.
- 5) A  selected option icon will appear on the selected item.
- 6) Press the direction button **LEFT** or **RIGHT** to select the next menu item.
- 7) Press the **MENU** button to exit the menu and return to your previous mode.
- 8) An icon reflecting your selection will display on the LCD screen.
- 9) This setting will be remembered by your camera until you manually change the setting or restore the camera's default factory settings.

Movie Size Menu

The Movie Size menu allows you to choose the desired size of the images taken by your camera. Keep in mind that images with a higher resolution will also take up more of your camera's memory.



- 1) Press the **MENU** button to open the menus for the current mode.
- 2) Press the direction button **LEFT** or **RIGHT** to scroll and select the Movie Size menu.
- 3) Press the direction button **UP** or **DOWN** to highlight the desired menu selection.
- 4) Press the **OK** button to confirm and select the highlighted menu option.
- 5) A  selected option icon will appear on the selected item.
- 6) Press the direction button **LEFT** or **RIGHT** to select the next menu item.
- 7) Press the **MENU** button to exit the menu and return to your previous mode.
- 8) An icon reflecting your selection will display on the LCD screen.
- 9) This setting will be remembered by your camera until you manually change the setting or restore the camera's default factory settings.

Image Quality Menu ★

The Image Quality menu allows you to select the desired quality level of the images taken by your camera. Keep in mind that images with a higher image quality level will also take up more memory on your camera.

- 1) Press the **MENU** button to open the menus for the current mode.
- 2) Press the direction button **LEFT** or **RIGHT** to scroll and select the Image Quality menu.
- 3) Press the direction button **UP** or **DOWN** to highlight the desired menu selection.
- 4) Press the **OK** button to confirm and select the highlighted menu option.
- 5) A  selected option icon will appear on the selected item.
- 6) Press the direction button **LEFT** or **RIGHT** to select the next menu item.
- 7) Press the **MENU** button to exit the menu and return to your previous mode.
- 8) An icon reflecting your selection will display on the LCD screen.
- 9) This setting will be remembered by your camera until you manually change the setting or restore the camera's default factory settings.

Anti-Shake Menu

The Anti-Shake feature reduces image corruption that can be caused by movement of the camera while capturing the image.

- 1) Press the **MENU** button to open the menus for the current mode.
- 2) Press the direction button **LEFT** or **RIGHT** to scroll and select the Anti-Shake menu.
- 3) Press the direction button **UP** or **DOWN** to highlight the desired menu selection.
- 4) Press the **OK** button to confirm and select the highlighted menu option.
- 5) A  selected option icon will appear on the selected item.
- 6) Press the direction button **LEFT** or **RIGHT** to select the next menu item.
- 7) Press the **MENU** button to exit the menu and return to your previous mode.
- 8) An icon reflecting your selection will display on the LCD screen.
- 9) This setting will be remembered by your camera until you manually change the setting or restore the camera's default factory settings.

White Balance Menu

The White Balance feature allows your camera to adjust the coloring of the captured images depending on the type of light source in the current environment.

Properly adjusting the White Balance setting to match your current environment will allow the camera to properly balance the colors in the images that are taken with your camera.

- 1) Press the **MENU** button to open the menus for the current mode.
- 2) Press the direction button **LEFT** or **RIGHT** to scroll and select the White Balance menu.
- 3) Press the direction button **UP** or **DOWN** to highlight the desired menu selection.
- 4) Press the **OK** button to confirm and select the highlighted menu option.
- 5) A  selected option icon will appear on the selected item.
- 6) Press the direction button **LEFT** or **RIGHT** to select the next menu item.
- 7) Press the **MENU** button to exit the menu and return to your previous mode.
- 8) An icon reflecting your selection will display on the LCD screen.
- 9) This setting will be remembered by your camera until you manually change the setting or restore the camera's default factory settings.

Color Effect Menu

You can choose to add a color effect to the images taken with your camera.



- 1) Press the **MENU** button to open the menus for the current mode.
- 2) Press the direction button **LEFT** or **RIGHT** to scroll and select the Color Effect menu.
- 3) Press the direction button **UP** or **DOWN** to highlight the desired menu selection.
- 4) Press the **OK** button to confirm and select the highlighted menu option.
- 5) A  selected option icon will appear on the selected item.
- 6) Press the direction button **LEFT** or **RIGHT** to select the next menu item.
- 7) Press the **MENU** button to exit the menu and return to your previous mode.
- 8) This setting will be remembered by your camera until you manually change the setting or restore the camera's default factory settings.

Image Sharpness Menu

You can set the level of sharpness in the images taken with your camera. The sharpness level dictates if the edges of objects in the image are more or less distinct.

- 1) Press the **MENU** button to open the menus for the current mode.
- 2) Press the direction button **LEFT** or **RIGHT** to scroll and select the Image Sharpness menu.
- 3) Press the direction button **UP** or **DOWN** to highlight the desired menu selection.
- 4) Press the **OK** button to confirm and select the highlighted menu option.
- 5) A  selected option icon will appear on the selected item.
- 6) Press the direction button **LEFT** or **RIGHT** to select the next menu item.
- 7) Press the **MENU** button to exit the menu and return to your previous mode.
- 8) An icon reflecting your selection will display on the LCD screen.
- 9) This setting will be remembered by your camera until you manually change the setting or restore the camera's default factory settings.

Light Exposure Menu

The Light Exposure setting helps you control the amount of light that enters your camera's lens. This setting should be adjusted when the environment is lighter or darker than normal.

When the environment has more light than is needed, reduce the exposure setting (by using the negative - count) to reduce the amount of light allowed into the lens by your camera.

If the environment has less light (darker) than is needed, increase the exposure setting (by using the positive + count) to increase the amount of light allowed into the lens by your camera.

- 1) Press the **MENU** button to open the menus for the current mode.
- 2) Press the direction button **LEFT** or **RIGHT** to scroll and select the Light Exposure menu.
- 3) Press the direction button **UP** or **DOWN** to highlight the desired menu selection.
- 4) Press the **OK** button to confirm and select the highlighted menu option.
- 5) A  selected option icon will appear on the selected item.
- 6) Press the direction button **LEFT** or **RIGHT** to select the next menu item.
- 7) Press the **MENU** button to exit the menu and return to your previous mode.

- 8) An icon reflecting your selection will display on the LCD screen.
- 9) This setting will be remembered by your camera until you manually change the setting or restore the camera's default factory settings.

ISO Menu

The ISO menu allows you to set the level of sensitivity that your camera has to light in the surrounding environment. When the ISO level is increased, the image sensor in your camera will be more sensitive to light and allow you to capture images in lower-light situations. The higher sensitivity to light however, may reduce the quality of the images that are taken.

When the ISO is reduced, the image sensor in your camera will be less sensitive to light and will optimize the image quality in environments with bright lighting.

- 1) Press the **MENU** button to open the menus for the current mode.
- 2) Press the direction button **LEFT** or **RIGHT** to scroll and select the ISO menu.
- 3) Press the direction button **UP** or **DOWN** to highlight the desired menu selection.
- 4) Press the **OK** button to confirm and select the highlighted menu option.
- 5) A  selected option icon will appear on the selected item.
- 6) Press the direction button **LEFT** or **RIGHT** to select the next menu item.
- 7) Press the **MENU** button to exit the menu and return to your previous mode.
- 8) An icon reflecting your selection will display on the LCD screen.
- 9) This setting will be remembered by your camera until you manually change the setting or restore the camera's default factory settings.

Metering Menu

The Metering setting will affect how your camera focuses when capturing an image. Depending on your selection, the camera will be more sensitive to focusing on particular areas in the display and adjust the image color and lighting accordingly.

Center – Averages the light metered from the entire frame, but giving greater weight to the subject in the center.

Multi – Used in standard conditions the camera divides and adjusts the settings of the image into several zones for light metering such as complex light conditions, position of subject, brightness, background, direct light and scenes.

Spot – Meters the area within the spot point frame at the center of the LCD to set the exposure on the subject in the center of the monitor.

- 1) Press the **MENU** button to open the menus for the current mode.
- 2) Press the direction button **LEFT** or **RIGHT** to scroll and select the Metering menu.
- 3) Press the direction button **UP** or **DOWN** to highlight the desired menu selection.
- 4) Press the **OK** button to confirm and select the highlighted menu option.
- 5) A  selected option icon will appear on the selected item.
- 6) Press the direction button **LEFT** or **RIGHT** to select the next menu item.
- 7) Press the **MENU** button to exit the menu and return to your previous mode.
- 8) An icon reflecting your selection will display on the LCD screen.
- 9) This setting will be remembered by your camera until you manually change the setting or restore the camera's default factory settings.

Language Menu

You can select your camera's language setting by selecting the desired language from the Language menu.

- 1) Press the **MENU** button to open the menus for the current mode.
- 2) Press the direction button **LEFT** or **RIGHT** to scroll and select the Language menu.
- 3) Press the direction button **UP** or **DOWN** to highlight the desired menu selection.
- 4) Press the **OK** button to confirm and select the highlighted menu option.
- 5) A  selected option icon will appear on the selected item.
- 6) Press the direction button **LEFT** or **RIGHT** to select the next menu item.
- 7) Press the **MENU** button to exit the menu and return to your previous mode.
- 8) This setting will be remembered by your camera until you manually change the setting or restore the camera's default factory settings.

Date/Time Menu

When you capture an image with your camera, the image will include a time stamp with the date and time that the image was taken.

The Date/Time menu allows you to set your camera's date and time as desired. You can also disable the timestamp for future images that will be taken with your camera.

On – The timestamp will appear on photos taken

Off – The date stamp will not appear on photos taken

To Enable/Disable the Timestamp:

- 1) Press the **MENU** button to open the menus for the current mode.
- 2) Press the direction button **LEFT** or **RIGHT** to scroll and select the Date/Time menu.
- 3) Press the direction button **UP** or **DOWN** to highlight the desired menu selection.
- 4) Press the **OK** button to confirm and select the highlighted menu option.
- 5) A  selected option icon will appear on the selected item.
- 6) Press the direction button **LEFT** or **RIGHT** to select the next menu item.
- 7) Press the **MENU** button to exit the menu and return to your previous mode.
- 8) This setting will be remembered by your camera until you manually change the setting or restore the camera's default factory settings.

To Set the Date and Time:

- 1) Press the **MENU** button to open the menus for the current mode.
- 2) Press the direction button **LEFT** or **RIGHT** to scroll and select the Date/Time menu.
- 3) Press the direction button **UP** or **DOWN** to highlight the "Date Setup" menu option, and then press the **OK** button to open the menu.
- 4) Scroll through the date and time menus with the **RIGHT** and **LEFT** direction button.
- 5) For each field in the menu, use the **UP** and **DOWN** direction button to set the specific date and time.
- 6) When you have finished setting the date and time, press the **OK** button to save your settings and return to the previous mode.
- 7) Press the **MENU** button to exit the menu without saving your settings and return to your previous screen.

Auto Power Off Menu

You can use the Auto Power Off feature in order to conserve your camera's battery life. The designated time represents when your camera will automatically power off.

When the camera sits idle for the designated period of time, the camera will shut off completely and will need to be turned on again with the power button before the next use.

- 1) Press the **MENU** button to open the menus for the current mode.
- 2) Press the direction button **LEFT** or **RIGHT** to scroll and select the Auto Power Off menu.
- 3) Press the direction button **UP** or **DOWN** to highlight the desired menu selection.
- 4) Press the **OK** button to confirm and select the highlighted menu option.
- 5) A  selected option icon will appear on the selected item.
- 6) Press the direction button **LEFT** or **RIGHT** to select the next menu item.
- 7) Press the **MENU** button to exit the menu and return to your previous mode.
- 8) This setting will be remembered by your camera until you manually change the setting or restore the camera's default factory settings.

Frequency Menu

The options in the Frequency menu represent the frequency of the electrical current in fluorescent lighting sources in your locale. If your camera is set to a frequency that does not match your country's electric current, you may see flickering or waves on the images taken by your camera.

50Hz – UK, Europe and Australia

60Hz – US, Canada and South America

- 1) Press the **MENU** button to open the menus for the current mode.
- 2) Press the direction button **LEFT** or **RIGHT** to scroll and select the Frequency menu.
- 3) Press the direction button **UP** or **DOWN** to highlight the desired menu selection.
- 4) Press the **OK** button to confirm and select the highlighted menu option.
- 5) A  selected option icon will appear on the selected item.
- 6) Press the direction button **LEFT** or **RIGHT** to select the next menu item.
- 7) Press the **MENU** button to exit the menu and return to your previous mode.
- 8) This setting will be remembered by your camera until you manually change the setting or restore the camera's default factory settings.

TV Out Menu

TV Out allows you to select the TV option appropriate for you to view your captured images on your television. See *“Connecting the Digital Video Camera to a TV”* for further information on how to connect your digital video camera to your television.

NTSC – television and video standard used in America, Canada

PAL – television and video standard used in Europe

- 1) Press the **MENU** button to open the menus for the current mode.
- 2) Press the direction button **LEFT** or **RIGHT** to scroll and select the TV Out menu.
- 3) Press the direction button **UP** or **DOWN** to highlight the desired menu selection.
- 4) Press the **OK** button to confirm and select the highlighted menu option.
- 5) A  selected option icon will appear on the selected item.
- 6) Press the direction button **LEFT** or **RIGHT** to select the next menu item.
- 7) Press the **MENU** button to exit the menu and return to your previous mode.
- 8) This setting will be remembered by your camera until you manually change the setting or restore the camera’s default factory settings.

Format Memory Card Menu

You can use the Format Memory Card menu to delete all of the content that is currently on your camera’s memory card.

Keep in mind that formatting the memory card will permanently delete all of the content on your camera’s memory card.

This option will delete all of the content at one time. If you would like to delete individual images, use the delete menu in the camera’s Playback mode or press the Delete button.

- 1) Press the **MENU** button to open the menus for the current mode.
- 2) Press the direction button **LEFT** or **RIGHT** to scroll and select the Format Memory Card menu.
- 3) Press the **OK** button to select the highlighted “Format?” option.
- 4) To exit without formatting the card, press the **MENU** button.
- 5) To proceed with the format, select “Yes” and press the **OK** button.

The SD Memory Card is automatically formatted and the camera returns to the previous mode.

To cancel the format, select “Cancel” and the camera returns to the Format menu.

Reset All Settings (Factory Default Settings) Menu

Use this menu to reset your camera settings to the Factory Default Settings.

- 1) Press the **MENU** button to open the menus for the current mode.
- 2) Press the direction button **LEFT** or **RIGHT** to scroll and select the Reset All Settings menu.
- 3) The “Default Setting” is selected.
- 4) Press the **OK** button to reset the camera to the factory default settings.
- 5) You will be asked to confirm the resetting to the factory default settings.
 - Select “No” and press the **OK** button to exit the menu and return to the previous menu without resetting to the default settings.
 - Select “Yes” and press the **OK** button to proceed with the reset.

You will then automatically exit the menu and return to the previous mode with the digital camera settings set to the Factory Default Settings.

Note: After RESETTING to the default settings, it is recommended to select your system Language and Date/Time. If you do not, the next time your camera is powered on, you will be prompted to define those settings.

Video Playback Mode

The Playback Mode allows you to review and edit photos and videos that you’ve already taken with you camera.

- When you first turn on the camera, the camera will be in Video Capture mode by default.
- Press the **MODE** button twice to open the **Playback** Mode.
- The latest captured image (video or photo) appears on the LCD screen.
If there are no images stored, a message (No File) appears.

Playing Videos on Your Camera

- 1) Select Your Video:
 - Once in Playback mode, Press the direction button **LEFT** or **RIGHT** to scroll through the images on your camera’s memory card until you find the video you would like to view.
 - Each captured image (video and photo) is displayed on the LCD screen.

- Videos appear with an '**AVI**' icon on the top left of the LCD screen.
- 2) Play Your Selected Video:
- Press the **Shutter** button to START playing the video.
 - Press the **Shutter** button again to PAUSE the video and to continue playing and pausing as needed.
 - To fully STOP the video and restore the icons to the LCD, press the **UP** button.
- NOTE:** While the Video is playing all the icons on the top section of the LCD disappear.

Thumbnail View

Easily navigate and select the image you wish to view by using the Thumbnail View.

The images on your camera will be displayed in a 3 X 3 matrix where you can use the direction buttons to scroll and select images from the thumbnails.

- 1) Press the  **DOWN / Zoom Out** button
- 2) All the images on your SD Card, both videos and photos, will appear in the Thumbnail View.
- 3) Press the direction button **UP / DOWN / LEFT / RIGHT** to scroll and select the image you wish to view.
Videos are shown with a video icon on the bottom left of the thumbnail.
- 4) Press the **OK** button to enlarge the selected image full size.
- 5) Once the selected video is full size you can play and view the video.

Video Playback Mode Quick Function Buttons

Your digital video camera has a four-directional direction control button that functions as Quick Function buttons.

Quick Function Button	Function
Left	- Displays the PREVIOUS image - Navigates in the Thumbnail View
Up	- Navigates in the Thumbnail View - STOPS the video playback
Right	- Displays the NEXT image - Navigates in the Thumbnail View
Down	Opens Thumbnail view NOTE: Use the LEFT/RIGHT/UP/DOWN buttons to navigate the

	Thumbnail View <ul style="list-style-type: none"> To select an AVI (video) in the Thumbnail View: press the OK button
--	---

Other

Shutter	STARTS and PAUSES the video playback
OK	Saves your selected option in the Menu view
 Delete	Opens the Delete Menu
MENU	- Opens the menu options for Video Capture Mode Note: Use the LEFT/RIGHT/UP/DOWN buttons to navigate the menus - Exits the menu screen
MODE	Toggles between the Video Capture Mode, Photo Capture Mode, and Playback Mode
DISPLAY	Hides or shows the display icons on the LCD screen

Video Playback Mode Menus

The following are the menus that appear in your digital video camera's Video Playback Mode:

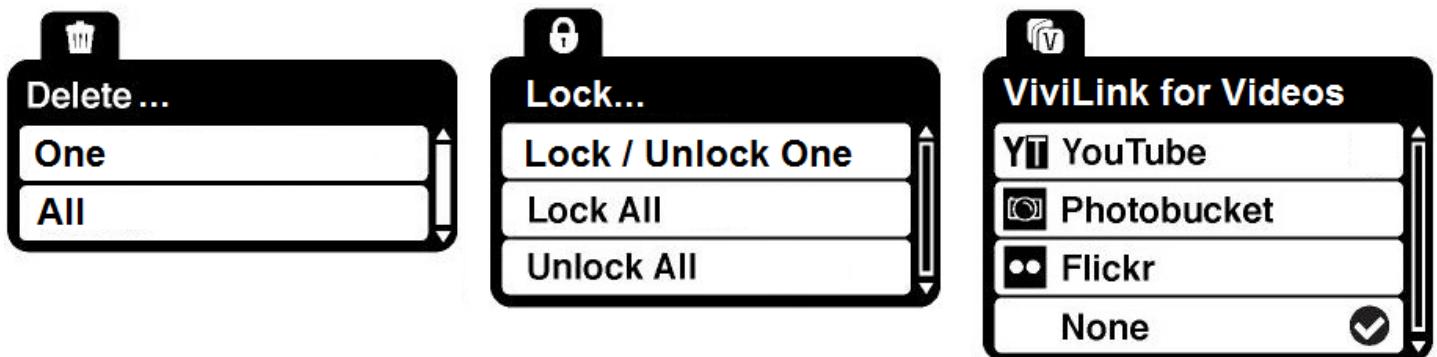

Delete Menu

While in the Playback mode, you can delete images (both videos and photos) from your digital video camera through the Delete menu.

Remember, you can also access the Delete menu simply by pressing the Delete quick function button.

- 1) View the image you would like to delete.
- 2) Press the **MENU** button to open the menus for the current mode.
- 3) Press the direction button **LEFT** or **RIGHT** to scroll and select the Delete menu.

- 4) Press the direction button **UP** or **DOWN** to scroll through the menu options.
- 5) To delete this one video, select “One”.
- 6) To delete all the images (including all unlocked photos and videos) on your camera’s memory card, select “All”.
- 7) Press the **OK** button to select and save the desired option.
- 8) You will be asked to confirm your selection.
- 9) The videos will be deleted as desired.

Lock Menu

Pictures and Videos taken with your camera can be protected or “locked” to prevent any deletion or alteration being made to the files.

- 1) Press the **MENU** button to open the menus for the current mode.
- 2) Press the direction button **LEFT** or **RIGHT** to scroll and select the Lock menu.
- 3) Press the direction button **UP** or **DOWN** to scroll through the menu options.
- 4) Press the **OK** button to select and save the desired option.
You will be asked to confirm your selection.
- 5) Press the **MENU** button to exit the menu and return to your previous mode.
- 6) Any image that is locked will display a lock symbol on the LCD screen when viewing that image in the playback mode. Videos that are not locked will not display the lock symbol.
- 7) Remember that you cannot delete locked images.

ViviLink for Videos Menu

The ViviLink technology allows you to quickly and easily upload your camera’s photos and videos to the social networks of your choice with the accompanying Vivitar Experience Image Manager application.

- 1) Press the **MENU** button to open the menus for the current mode.
- 2) Press the direction button **LEFT** or **RIGHT** to scroll and select the ViviLink for Videos menu.
- 3) Press the direction button **UP** or **DOWN** to highlight the desired menu selection.
- 4) Press the **OK** button to confirm and select the highlighted menu option.

- 5) A  selected option icon will appear on the selected item.
- 6) An icon will appear on the image with the selected ViviliLink destination site.
- 7) Remember that the ViviliLink feature is deactivated by default. A ViviliLink destination will only be assigned to a photo or video if you manually set it from this menu, from the ViviliLink menu in Photo Playback mode, or from the menu accessed by pressing the **ViviliLink** button in the Video Capture Mode.
- 8) Changing the ViviliLink destination site will also make the selected site the new default ViviliLink option. A new default can be selected at any time through this menu.

Photo Capture Mode

The Photo Capture mode allows you to capture pictures with your digital camera.

After powering on the digital video camera, press the **MODE** button once to open the **Photo Capture** Mode.

Taking a Picture







- 1) While in Photo Capture mode, use the LCD display to direct the camera at the scene you would like to capture.
- 2) Press the  **UP/Zoom In** and  **DOWN/Zoom Out** buttons to better set the camera display if desired.
- 3) Press the **RIGHT/LED ON-OFF** button to turn the LED light On to better illuminate the area you would like to capture.
- 4) Press the **Shutter** button to capture your photo.
- 5) The picture will automatically be saved to the SD Memory card.

Photo Capture Mode Quick Function Buttons

Your digital video camera has a four-directional direction control button that functions as Quick Function buttons.

Quick Function Button	Function
 Left	ViviLink - Opens the ViviLink menu
 Up	Zooms In
 Right	Turns on and off the LED light
 Down	Zooms out

Other

Shutter/OK	Captures your photo
-------------------	---------------------

 Delete	Delete Image - Opens the Delete Menu with the option to delete the last captured image (video or photo) or to delete all, unlocked captured images
MENU	<ul style="list-style-type: none"> - Opens the menu options for Photo Capture Mode - Exits the menu screen - Note: Use the LEFT/RIGHT/UP/DOWN buttons to navigate the menus.
OK	Saves your selected option in the Menu view
MODE	Toggles between the Video Capture Mode, Photo Capture Mode, and Playback Mode
DISPLAY	Hides or shows the display icons on the LCD screen

LED Flash Option

- To increase the lighting in dark situations, press the **RIGHT** button to activate the LED Flash Light on the front of the camera below the lens.
- Press the **RIGHT** button again to turn the LED Flash Lights off.

Photo Capture Mode Menus

The following are the menus that appear in your digital video camera's Photo Capture Mode:

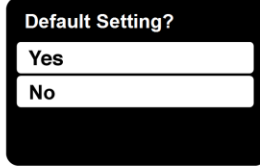
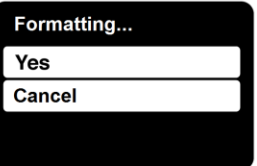
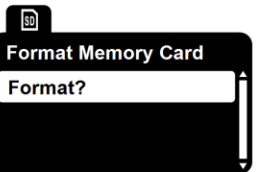
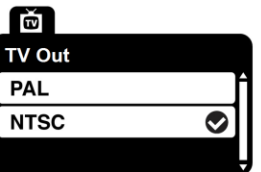
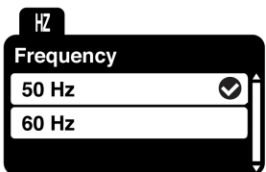
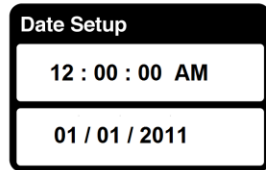
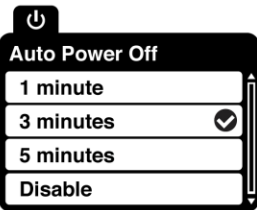
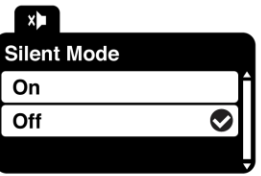
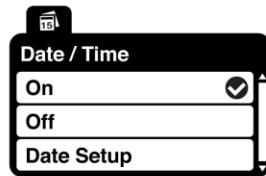
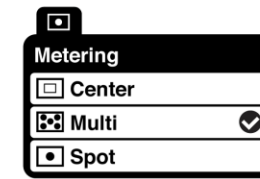
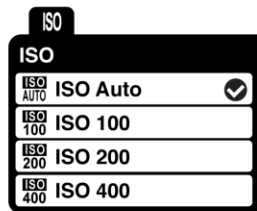
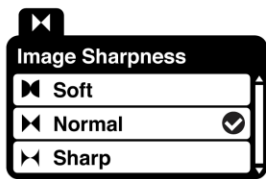
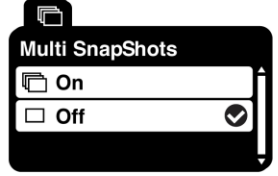
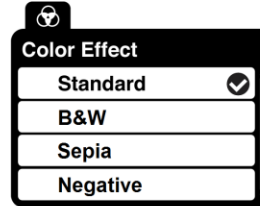
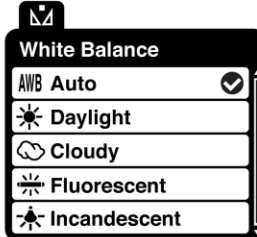
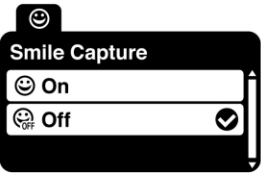
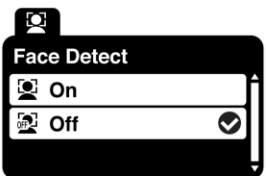
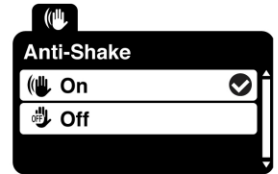
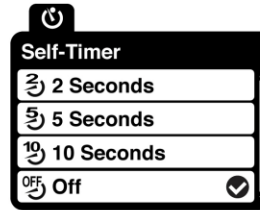
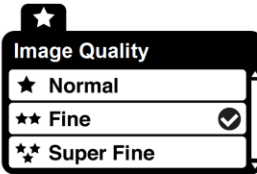
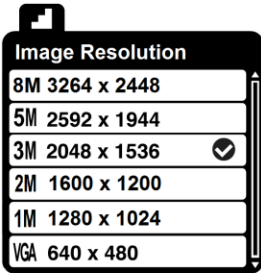

Scene Menu

The Scene Menu allows you to choose scene settings that let your camera to adapt properly to your current environment.

- 1) Press the **MENU** button to open the menus for the current mode.
- 2) Press the direction button **LEFT** or **RIGHT** to scroll and select the Scene menu.
- 3) Press the direction button **UP** or **DOWN** to highlight the desired menu selection.
- 4) Press the **OK** button to confirm and select the highlighted menu option.
- 5) A  selected option icon will appear on the selected item.
- 6) Press the direction button **LEFT** or **RIGHT** to select the next menu item.
- 7) Press the **MENU** button to exit the menu and return to your previous mode.
- 8) An icon reflecting your selection will display on the LCD screen.
- 9) This setting will be remembered by your camera until you manually change the setting or restore the camera's default factory settings.

Image Resolution Menu

The Image Resolution menu allows you to choose the desired size of the images taken by your camera. Keep in mind that images with a higher resolution will also take up more of your camera's memory.



- 1) Press the **MENU** button to open the menus for the current mode.
- 2) Press the direction button **LEFT** or **RIGHT** to scroll and select the Image Resolution menu.
- 3) Press the direction button **UP** or **DOWN** to highlight the desired menu selection.
- 4) Press the **OK** button to confirm and select the highlighted menu option.
- 5) A  selected option icon will appear on the selected item.
- 6) Press the direction button **LEFT** or **RIGHT** to select the next menu item.
- 7) Press the **MENU** button to exit the menu and return to your previous mode.
- 8) An icon reflecting your selection will display on the LCD screen.
- 9) This setting will be remembered by your camera until you manually change the setting or restore the camera's default factory settings.

Image Quality Menu ★

The Image Quality menu allows you to select the desired quality level of the images taken by your camera. Keep in mind that images with a higher image quality level will also take up more memory on your camera.

- 1) Press the **MENU** button to open the menus for the current mode.
- 2) Press the direction button **LEFT** or **RIGHT** to scroll and select the Image Quality menu.
- 3) Press the direction button **UP** or **DOWN** to highlight the desired menu selection.
- 4) Press the **OK** button to confirm and select the highlighted menu option.
- 5) A  selected option icon will appear on the selected item.
- 6) Press the direction button **LEFT** or **RIGHT** to select the next menu item.
- 7) Press the **MENU** button to exit the menu and return to your previous mode.
- 8) An icon reflecting your selection will display on the LCD screen.
- 9) This setting will be remembered by your camera until you manually change the setting or restore the camera's default factory settings.

Self-Timer Menu

The Self-Timer menu allows you to set a delay between the time that the camera's Shutter button is pressed and the actual capture of the picture.

This is an optimal feature if you don't just want to take the picture but would also like to be in the picture yourself. Just set the desired Self-Timer delay, press the **Shutter** button on your camera and position yourself in front of the camera as desired.

- 1) Press the **MENU** button to open the menus for the current mode.
- 2) Press the direction button **LEFT** or **RIGHT** to scroll and select the Self-Timer menu.
- 3) Press the direction button **UP** or **DOWN** to highlight the desired menu selection.
- 4) Press the **OK** button to confirm and select the highlighted menu option.
- 5) A  selected option icon will appear on the selected item.
- 6) Press the direction button **LEFT** or **RIGHT** to select the next menu item.
- 7) Press the **MENU** button to exit the menu and return to your previous mode.
- 8) An icon reflecting your selection will display on the LCD screen.
- 9) This setting will be remembered by your camera until you manually change the setting or restore the camera's default factory settings.

Anti-Shake Menu

The Anti-Shake feature reduces image corruption that can be caused by movement of the camera while capturing the image.

- 1) Press the **MENU** button to open the menus for the current mode.
- 2) Press the direction button **LEFT** or **RIGHT** to scroll and select the Anti-Shake menu.
- 3) Press the direction button **UP** or **DOWN** to highlight the desired menu selection.
- 4) Press the **OK** button to confirm and select the highlighted menu option.
- 5) A  selected option icon will appear on the selected item.
- 6) Press the direction button **LEFT** or **RIGHT** to select the next menu item.
- 7) Press the **MENU** button to exit the menu and return to your previous mode.
- 8) An icon reflecting your selection will display on the LCD screen.
- 9) This setting will be remembered by your camera until you manually change the setting or restore the camera's default factory settings.

Face Detect Menu

The Face Detect feature, when set to 'On', allows the camera to use a subject's face as the basis for balancing the other colors and focus in the camera's display. This feature is meant to ensure that the color and focus of your pictures will be consistently sharp and high-quality.

Note: To properly use the Face Detect option, please ensure the following:

- **Anti-Shake** - Ensure that the Anti-Shake option is set to 'On'. The Anti-Shake option is 'On' by default when you start using your camera and assists you in properly focusing the image.
- **Distance from the camera** – The subject's face must be no further than 8 to 9 feet (3.5 meters) from the camera and the face must cover at least 20% (1 / 5th) of the picture as 'seen' on the LCD screen.
- **Facing the camera** - The face of the subject(s) you are photographing must be facing the camera and must hold the pose for at least 4 to 5 seconds until the green square(s) appears around the subject's face.

Face Detect will not work with a side shot of the subject's head.

- 1) Press the MENU button to open the menus for the current mode.
- 2) Press the LEFT or RIGHT button to scroll and select the Face Detect menu.

- 3) Press the UP or DOWN button to scroll through the menu options.
- 4) Press the OK button to select and save the desired option.
- 5) A  selected option icon will appear on the selected item.
- 6) Press the LEFT or RIGHT button to select the next menu item.
- 7) Press the MENU button to exit the menu and return to your previous mode.
- 8) An icon reflecting your selection will display on the LCD screen.
- 9) This setting will be saved by your camera until you manually change the setting or restore the camera's default factory settings.

Smile Capture Menu

The Smile Capture feature, when set to 'On', allows the camera to automatically take a picture when it detects that a subject in the picture is smiling.

Note: To properly use the Smile Capture feature, please ensure the following:

- **Anti-Shake** - Ensure that the Anti-Shake option is set to 'On'. The Anti-Shake option is 'On' by default when you start using your camera and assists you in properly focusing the image.
- **Distance from the camera** – The subject's face must cover a majority of the picture when previewed on the LCD screen.
- **Facing the camera** - The face of the subject(s) you are photographing must be facing the camera and must hold the pose for at least 4 to 5 seconds until the green square(s) appears around the subject's face.

Once a smile is detected the camera will automatically take the picture.

Smile Capture will not work with a side shot of the subject's head.

- 1) Press the MENU button to open the menus for the current mode.
- 2) Press the LEFT or RIGHT button to scroll and select the Smile Capture menu.
- 3) Press the UP or DOWN button to scroll through the menu options.
- 4) Press the OK button to select and save the desired option.
- 5) A  selected option icon will appear on the selected item.
- 6) Press the LEFT or RIGHT button to select the next menu item.
- 7) Press the MENU button to exit the menu and return to your previous mode.
- 8) An icon reflecting your selection will display on the LCD screen.

- 9) This setting will be saved by your camera until you manually change the setting or restore the camera's default factory settings.

White Balance Menu

The White Balance feature allows your camera to adjust the coloring of the captured images depending on the type of light source in the current environment.

Properly adjusting the White Balance setting to match your current environment will allow the camera to properly balance the colors in the images that are taken with your camera.

- 1) Press the **MENU** button to open the menus for the current mode.
- 2) Press the direction button **LEFT** or **RIGHT** to scroll and select the White Balance menu.
- 3) Press the direction button **UP** or **DOWN** to highlight the desired menu selection.
- 4) Press the **OK** button to confirm and select the highlighted menu option.
- 5) A  selected option icon will appear on the selected item.
- 6) Press the direction button **LEFT** or **RIGHT** to select the next menu item.
- 7) Press the **MENU** button to exit the menu and return to your previous mode.
- 8) An icon reflecting your selection will display on the LCD screen.
- 9) This setting will be remembered by your camera until you manually change the setting or restore the camera's default factory settings.

Color Effect Menu

You can choose to add a color effect to the images taken with your camera.

- 1) Press the **MENU** button to open the menus for the current mode.
- 2) Press the direction button **LEFT** or **RIGHT** to scroll and select the Color Effect menu.
- 3) Press the direction button **UP** or **DOWN** to highlight the desired menu selection.
- 4) Press the **OK** button to confirm and select the highlighted menu option.
- 5) A  selected option icon will appear on the selected item.
- 6) Press the direction button **LEFT** or **RIGHT** to select the next menu item.
- 7) Press the **MENU** button to exit the menu and return to your previous mode.
- 8) This setting will be remembered by your camera until you manually change the setting or restore the camera's default factory settings.

Multi Snapshots Menu

When enabled, the Multi Snapshots feature allows you to take three rapid snapshots in a row with a single click of the Shutter button.

This feature can be effective when trying to capture a particular moment in a sporting event or other scenes with quick movements.



- 1) Press the **MENU** button to open the menus for the current mode.
- 2) Press the direction button **LEFT** or **RIGHT** to scroll and select the Multi Snapshots menu.
- 3) Press the direction button **UP** or **DOWN** to highlight the desired menu selection.
- 4) Press the **OK** button to confirm and select the highlighted menu option.
- 5) A  selected option icon will appear on the selected item.
- 6) Press the direction button **LEFT** or **RIGHT** to select the next menu item.
- 7) Press the **MENU** button to exit the menu and return to your previous mode.
- 8) An icon reflecting your selection will display on the LCD screen.
- 9) This setting will be remembered by your camera until you manually change the setting or restore the camera's default factory settings.

Image Sharpness Menu

You can set the level of sharpness in the images taken with your camera. The sharpness level dictates if the edges of objects in the image are more or less distinct.

- 1) Press the **MENU** button to open the menus for the current mode.
- 2) Press the direction button **LEFT** or **RIGHT** to scroll and select the Image Sharpness menu.
- 3) Press the direction button **UP** or **DOWN** to highlight the desired menu selection.
- 4) Press the **OK** button to confirm and select the highlighted menu option.
- 5) A  selected option icon will appear on the selected item.
- 6) Press the direction button **LEFT** or **RIGHT** to select the next menu item.
- 7) Press the **MENU** button to exit the menu and return to your previous mode.
- 8) An icon reflecting your selection will display on the LCD screen.
- 9) This setting will be remembered by your camera until you manually change the setting or restore the camera's default factory settings.

Light Exposure Menu

The Light Exposure setting helps you control the amount of light that enters your camera's lens. This setting should be adjusted when the environment is lighter or darker than normal.

When the environment has more light than is needed, reduce the exposure setting (by using the negative - count) to reduce the amount of light allowed into the lens by your camera.

If the environment has less light (darker) than is needed, increase the exposure setting (by using the positive + count) to increase the amount of light allowed into the lens by your camera.

- 1) Press the **MENU** button to open the menus for the current mode.
- 2) Press the direction button **LEFT** or **RIGHT** to scroll and select the Light Exposure menu.
- 3) Press the direction button **UP** or **DOWN** to highlight the desired menu selection.
- 4) Press the **OK** button to confirm and select the highlighted menu option.
- 5) A  selected option icon will appear on the selected item.
- 6) Press the direction button **LEFT** or **RIGHT** to select the next menu item.
- 7) Press the **MENU** button to exit the menu and return to your previous mode.
- 8) An icon reflecting your selection will display on the LCD screen.
- 9) This setting will be remembered by your camera until you manually change the setting or restore the camera's default factory settings.

ISO Menu

The ISO menu allows you to set the level of sensitivity that your camera has to light in the surrounding environment. When the ISO level is increased, the image sensor in your camera will be more sensitive to light and allow you to capture images in lower-light situations. The higher sensitivity to light however, may reduce the quality of the images that are taken.

When the ISO is reduced, the image sensor in your camera will be less sensitive to light and will optimize the image quality in environments with bright lighting.

- 1) Press the **MENU** button to open the menus for the current mode.
- 2) Press the direction button **LEFT** or **RIGHT** to scroll and select the ISO menu.

- 3) Press the direction button **UP** or **DOWN** to highlight the desired menu selection.
- 4) Press the **OK** button to confirm and select the highlighted menu option.
- 5) A  selected option icon will appear on the selected item.
- 6) Press the direction button **LEFT** or **RIGHT** to select the next menu item.
- 7) Press the **MENU** button to exit the menu and return to your previous mode.
- 8) An icon reflecting your selection will display on the LCD screen.
- 9) This setting will be remembered by your camera until you manually change the setting or restore the camera's default factory settings.

Metering Menu

The Metering setting will affect how your camera focuses when capturing an image. Depending on your selection, the camera will be more sensitive to focusing on particular areas in the display and adjust the image color and lighting accordingly.

Center – Averages the light metered from the entire frame, but giving greater weight to the subject in the center

Multi – Used in standard conditions the camera divides and adjusts the settings of the image into several zones for light metering such as complex light conditions, position of subject, brightness, background, direct light and scenes

Spot – Meters the area within the spot point frame at the center of the LCD to set the exposure on the subject in the center of the monitor.

- 1) Press the **MENU** button to open the menus for the current mode.
- 2) Press the direction button **LEFT** or **RIGHT** to scroll and select the Metering menu.
- 3) Press the direction button **UP** or **DOWN** to highlight the desired menu selection.
- 4) Press the **OK** button to confirm and select the highlighted menu option.
- 5) A  selected option icon will appear on the selected item.
- 6) Press the direction button **LEFT** or **RIGHT** to select the next menu item.
- 7) Press the **MENU** button to exit the menu and return to your previous mode.
- 8) An icon reflecting your selection will display on the LCD screen.
- 9) This setting will be remembered by your camera until you manually change the setting or restore the camera's default factory settings.

Language Menu

You can select your camera's language setting by selecting the desired language from the Language menu.

- 1) Press the **MENU** button to open the menus for the current mode.
- 2) Press the direction button **LEFT** or **RIGHT** to scroll and select the Language menu.
- 3) Press the direction button **UP** or **DOWN** to highlight the desired menu selection.
- 4) Press the **OK** button to confirm and select the highlighted menu option.
- 5) A  selected option icon will appear on the selected item.
- 6) Press the direction button **LEFT** or **RIGHT** to select the next menu item.
- 7) Press the **MENU** button to exit the menu and return to your previous mode.
- 8) This setting will be remembered by your camera until you manually change the setting or restore the camera's default factory settings.

Date/Time Menu

When you capture an image with your camera, the image will include a time stamp with the date and time that the image was taken.

The Date/Time menu allows you to set your camera's date and time as desired. You can also disable the timestamp for future images that will be taken with your camera.

On – The timestamp will appear on photos taken

Off – The date stamp will not appear on photos taken

To Enable/Disable the Timestamp:

- 1) Press the **MENU** button to open the menus for the current mode.
- 2) Press the direction button **LEFT** or **RIGHT** to scroll and select the Date/Time menu.
- 3) Press the direction button **UP** or **DOWN** to highlight the desired menu selection.
- 4) Press the **OK** button to confirm and select the highlighted menu option.
- 5) A  selected option icon will appear on the selected item.
- 6) Press the direction button **LEFT** or **RIGHT** to select the next menu item.
- 7) Press the **MENU** button to exit the menu and return to your previous mode.
- 8) This setting will be remembered by your camera until you manually change the setting or restore the camera's default factory settings.

To Set the Date and Time:

- 1) Press the **MENU** button to open the menus for the current mode.
- 2) Press the direction button **LEFT** or **RIGHT** to scroll and select the Date/Time menu.
- 3) Press the direction button **UP** or **DOWN** to highlight the “Date Setup” menu option, and then press the **OK** button to open the menu.
- 4) Scroll through the date and time menus with the **RIGHT** and **LEFT** direction button.
- 5) For each field in the menu, use the **UP** and **DOWN** direction button to set the specific date and time.
- 6) When you have finished setting the date and time, press the **OK** button to save your settings and return to the previous mode.
- 7) Press the **MENU** button to exit the menu without saving your settings and return to your previous screen.

Silent Mode Menu

You have the option of activating the camera’s Silent mode to disable all of the sound effects (except for beeps heard during the Self-Timer countdown) that the camera emits when performing camera functions.

- 1) Press the **MENU** button to open the menus for the current mode.
- 2) Press the direction button **LEFT** or **RIGHT** to scroll and select the Silent Mode menu.
- 3) Press the direction button **UP** or **DOWN** to highlight the desired menu selection.
- 4) Press the **OK** button to confirm and select the highlighted menu option.
- 5) A  selected option icon will appear on the selected item.
- 6) Press the direction button **LEFT** or **RIGHT** to select the next menu item.
- 7) Press the **MENU** button to exit the menu and return to your previous mode.
- 8) This setting will be remembered by your camera until you manually change the setting or restore the camera’s default factory settings.

Auto Power Off Menu

You can use the Auto Power Off feature in order to conserve you camera’s battery life. The designated time represents when your camera will automatically power off.

When the camera sits idle for the designated period of time, the camera will shut off completely and will need to be turned on again with the power button before the next use.

- 1) Press the **MENU** button to open the menus for the current mode.
- 2) Press the direction button **LEFT** or **RIGHT** to scroll and select the Auto Power Off menu.
- 3) Press the direction button **UP** or **DOWN** to highlight the desired menu selection.
- 4) Press the **OK** button to confirm and select the highlighted menu option.
- 5) A  selected option icon will appear on the selected item.
- 6) Press the direction button **LEFT** or **RIGHT** to select the next menu item.
- 7) Press the **MENU** button to exit the menu and return to your previous mode.
- 8) This setting will be remembered by your camera until you manually change the setting or restore the camera's default factory settings.

Frequency Menu ^{HZ}

The options in the Frequency menu represent the frequency of the electrical current in fluorescent lighting sources in your locale. If your camera is set to a frequency that does not match your country's electric current, you may see flickering or waves on the images taken by your camera.

50Hz – UK, Europe and Australia

60Hz – US, Canada and South America

- 1) Press the **MENU** button to open the menus for the current mode.
- 2) Press the direction button **LEFT** or **RIGHT** to scroll and select the Frequency menu.
- 3) Press the direction button **UP** or **DOWN** to highlight the desired menu selection.
- 4) Press the **OK** button to confirm and select the highlighted menu option.
- 5) A  selected option icon will appear on the selected item.
- 6) Press the direction button **LEFT** or **RIGHT** to select the next menu item.
- 7) Press the **MENU** button to exit the menu and return to your previous mode.
- 8) This setting will be remembered by your camera until you manually change the setting or restore the camera's default factory settings.

TV Out Menu

TV Out allows you to select the TV option appropriate for you to view your captured images on your television. See *“Connecting the Digital Video Camera to a TV”* for further information on how to connect your digital video camera to your television.

NTSC – television and video standard used in America, Canada

PAL – television and video standard used in Europe

- 1) Press the **MENU** button to open the menus for the current mode.
- 2) Press the direction button **LEFT** or **RIGHT** to scroll and select the TV Out menu.
- 3) Press the direction button **UP** or **DOWN** to highlight the desired menu selection.
- 4) Press the **OK** button to confirm and select the highlighted menu option.
- 5) A  selected option icon will appear on the selected item.
- 6) Press the direction button **LEFT** or **RIGHT** to select the next menu item.
- 7) Press the **MENU** button to exit the menu and return to your previous mode.
- 8) This setting will be remembered by your camera until you manually change the setting or restore the camera’s default factory settings.

Format Memory Card Menu

You can use the Format Memory Card menu to delete all of the content that is currently on your camera’s memory card.

Keep in mind that formatting the memory card will permanently delete all of the content on your camera’s memory card.

This option will delete all of the content at one time. If you would like to delete individual images, use the delete menu in the camera’s Playback mode or press the Delete button.

- 1) Press the **MENU** button to open the menus for the current mode.
- 2) Press the direction button **LEFT** or **RIGHT** to scroll and select the Format Memory Card menu.
- 3) Press the **OK** button to select the highlighted “Format?” option.
- 4) To exit without formatting the card, press the **MENU** button.
- 5) To proceed with the format, select “Yes” and press the **OK** button.

The SD Memory Card is automatically formatted and the camera returns to the previous mode.

To cancel the format, select “Cancel” and the camera returns to the Format menu.

Reset All Settings (Factory Default Settings) Menu

Use this menu to reset your camera settings to the Factory Default Settings.

- 1) Press the **MENU** button to open the menus for the current mode.
- 2) Press the direction button **LEFT** or **RIGHT** to scroll and select the Reset All Settings menu.
- 3) The “Default Setting” is selected.
- 4) Press the **OK** button to reset the camera to the factory default settings.
- 5) You will be asked to confirm the resetting to the factory default settings.
 - Select “No” and press the **OK** button to exit the menu and return to the previous menu without resetting to the default settings.
 - Select “Yes” and press the **OK** button to proceed with the reset.

You will then automatically exit the menu and return to the previous mode with the digital camera settings set to the Factory Default Settings.

Note: After RESETTING to the default settings, it is recommended to select your system Language and Date/Time. If you do not, the next time your camera is powered on, you will be prompted to define those settings.

Photo Playback Mode

The Playback Mode allows you to review and edit photos and videos that you've already taken with your camera.



- When you first turn on the camera, the camera will be in Video Capture mode by default.
- Press the **MODE** button twice to open the **Playback** Mode.
- The latest captured image appears on the LCD screen. If there are no images stored, a message (No File) appears.

Viewing Photos on Your Camera

1) Select your Photo:

- Once in Playback Mode, Press the direction button **LEFT** or **RIGHT** to scroll through the images on your camera's memory card until you find the image you would like to view.
- Each captured image (video and photo) is displayed on the LCD screen.
- Photos appear with a 'JPG' icon on the top left of the LCD screen.

2) Zooming In/Out of your selected Photo:

- Press the  **UP/Zoom In** button to Zoom In and magnify the selected photo. Use the **UP / DOWN / LEFT / RIGHT** buttons to navigate around the photo.
Note: Press the **OK** button to return to viewing the photo without magnification.
- Press the  **DOWN/Zoom Out** button to Zoom Out of the selected photo. Use the **UP / DOWN / LEFT / RIGHT** direction buttons to navigate around the photo.

Thumbnail View

Easily navigate and select the image you wish to view by using the Thumbnail View.

The images on your camera will be displayed in a 3 X 3 matrix where you can use the direction buttons to scroll and select images from the thumbnails.

- 1) Press the  **DOWN/Zoom Out** button
- 2) All the images on your camera, both videos and photos, will appear in the Thumbnail View.
- 3) Press the direction button **UP / DOWN / LEFT / RIGHT** to scroll and select the image you wish to view.
- 4) Press the **OK** button to enlarge the selected image full size.
- 5) Once the selected photo is full size, you can Zoom In or Zoom Out of the selected photo.

Photo Playback Mode Quick Function Buttons

Your digital video camera has a four-directional direction control button that functions as Quick Function buttons.

Quick Function Button	Function
Left	- Displays the PREVIOUS image - Navigates in the Thumbnail View
Up	- Zooms In to the photo - Navigates in the Thumbnail View - Stops the Photo Slide Show
Right	- Displays the NEXT image - Navigates in the Thumbnail View
Down	- Opens Thumbnail view NOTE: To Navigate in the Thumbnail View: Press the direction button UP / DOWN / LEFT / RIGHT - Zooms Out of the zoomed in photo

Other

Shutter	Pauses and continues the Photo Slide Show
OK	Selects Thumbnail image Saves your selected option in the Menu view
 Delete	Opens the Delete Menu
MENU	- Opens the menu options for Video Capture Mode Note: Use the LEFT/RIGHT/UP/DOWN buttons to navigate the menus - Exits the menu screen
MODE	Toggles between the Video Capture Mode, Photo Capture Mode, and Playback Mode
DISPLAY	Hides or shows the display icons on the LCD screen

Photo Playback Mode Menus

The following are the menus that appear in your digital video camera's Photo Playback Mode:

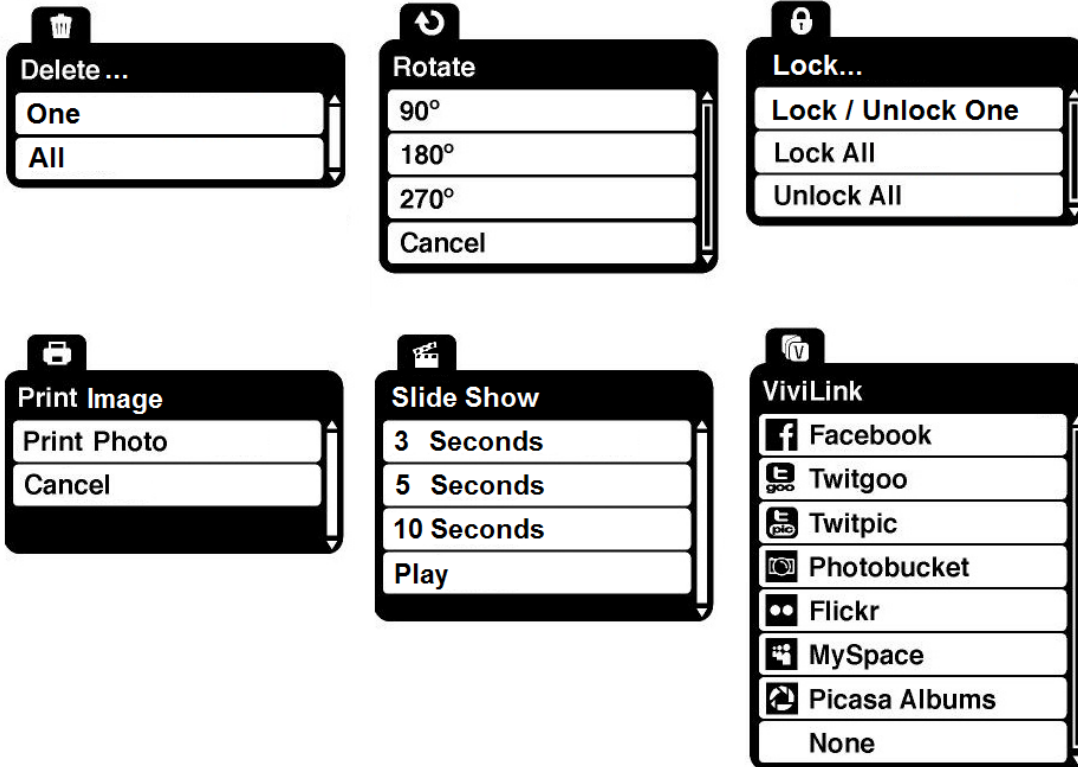

Delete Menu

While in the Playback mode, you can delete images (both videos and photos) from your digital video camera through the Delete menu.

Remember, you can also access the Delete menu simply by pressing the Delete quick function button.

- 1) View the image you would like to delete.
- 2) Press the **MENU** button to open the menus for the current mode.
- 3) Press the direction button **LEFT** or **RIGHT** to scroll and select the Delete menu.
- 4) Press the direction button **UP** or **DOWN** to scroll through the menu options.
- 5) To delete this one video, select "One".
- 6) To delete all the images (including all unlocked photos and videos) on your camera's memory card, select "All".
- 7) Press the **OK** button to select and save the desired option.
- 8) You will be asked to confirm your selection.
- 9) The videos will be deleted as desired.

Rotate Menu

Use this menu to rotate the pictures that you've taken with your camera.

- 1) Press the **MENU** button to open the menus for the current mode.
- 2) Press the direction button **LEFT** or **RIGHT** to scroll and select the Rotate menu.
- 3) Press the direction button **UP** or **DOWN** to highlight the desired menu selection.
- 4) Press the **OK** button to confirm and select the highlighted menu option.
- 5) The selected picture will now appear rotated in the Playback mode – saved as a separate photo.
- 6) Press the direction button **LEFT** or **RIGHT** to select the next menu item.
- 7) Press the **MENU** button to exit the menu and return to your previous mode.

Lock Menu

Pictures and Videos taken with your camera can be protected or “locked” to prevent any deletion or alteration being made to the files.

- 1) Press the **MENU** button to open the menus for the current mode.
- 2) Press the direction button **LEFT** or **RIGHT** to scroll and select the Lock menu.
- 3) Press the direction button **UP** or **DOWN** to scroll through the menu options.
- 4) Press the **OK** button to select and save the desired option.
You will be asked to confirm your selection.
- 5) Press the **MENU** button to exit the menu and return to your previous mode.
- 6) Any image that is locked will display a lock symbol on the LCD screen when viewing that image in the playback mode. Videos that are not locked will not display the lock symbol.
- 7) Remember that you cannot delete locked images.

Print Photo Menu

You can use the Print Photos menu to print the photos that are on your camera directly to a Pictbridge compatible printer.

- 1) Scroll through your pictures and find the one you would like to print.
- 2) Press the **MENU** button to open the menus for the current mode.
- 3) Press the direction button **LEFT** or **RIGHT** to scroll and select the Print This Photo menu.

- 4) Press the direction button **UP** or **DOWN** to scroll through the menu options.
- 5) Press the **OK** button when highlighting the “Print Photo” option to print the selected photo.
- 6) You will be asked to connect the camera to the Pictbridge printer.
- 7) Connect the camera to the Pictbridge port of the printer using the built-in USB Connector.
- 8) Once connected, follow the instructions on the printer to proceed with the printing process.
- 9) Select the “Cancel” option to exit the menu and return to the previous mode.

Slide Show Menu

You can view a Slide Show of all the pictures taken with your camera while in Playback mode. The Slide Show menu allows you to set the interval length of time that each picture will display during the Slide Show.

- 1) Select a photo then press the **MENU** button to open the menus for the current mode.
- 2) Press the **LEFT** or **RIGHT** direction control buttons to scroll and select the Slide Show menu.
- 3) Press the **UP** or **DOWN** direction control buttons to scroll through the menu options.
- 4) Press the **OK** button to select and save the desired option.
- 5) A  selected option icon will appear on the selected item.
- 6) To play the Slide Show select ‘Play’ then press **OK** to begin the Slide Show according to the settings you selected.

Press the **Shutter** button to pause and then continue the Slide Show.

Press the **UP** button to exit the Slide Show and return to Playback Mode.

ViviLink Menu

The ViviLink technology allows you to quickly and easily upload your camera’s photos and videos to the social networks of your choice with the accompanying Vivitar Experience Image Manager application.

- 1) Press the **MENU** button to open the menus for the current mode.
- 2) Press the direction button **LEFT** or **RIGHT** to scroll and select the ViviLink menu.
- 3) Press the direction button **UP** or **DOWN** to highlight the desired menu selection.
- 4) Press the **OK** button to confirm and select the highlighted menu option.
- 5) A  selected option icon will appear on the selected item.

- 6) Press the direction button **LEFT** or **RIGHT** to select the next menu item.
- 7) Press the **MENU** button to exit the menu and return to your previous mode.
- 8) An icon will appear on the image with the selected Vivilink destination site.
- 9) Remember that the Vivilink feature is deactivated by default. A Vivilink destination will only be assigned to a photo or video if you manually set it from this menu, from the Vivilink menu in Photo Playback mode, or from the menu accessed by pressing the **ViviLink** button.
- 10) Changing the Vivilink destination site will also make the selected site the new default Vivilink option. A new default can be selected at any time through this menu.

Connecting the Digital Video Camera to a TV

The camera has an AV port to use your larger TV screen in place of the camera's LCD screen. On plugging the TV-out cable (supplied) to the camera's AV out jack, the LCD screen turns blank. Use the camera as you would to capture and playback photos and videos. The images will appear on the TV instead of on the LCD screen.

Note: The only limitation of using the TV screen is that the camera is now not portable.

- 1) Connect the camcorder to a TV via the TV-out cable (supplied).
- 2) Turn on the TV and the camera, and then set the TV to "AV" mode.
- 3) You will need to set the TV format on the camera to suit the TV format of your TV set.
- 4) Make sure the camera is set to the correct TV Output setting. On plugging in the TV out cable a message will appear on the LCD screen to select NTSC or PAL for the type of TV you are using.
- 5) Select the option as per the format of the TV set you are using and press the **OK** button.
- 6) When the camera is set to record mode, you can preview the subjects you want to record on the TV screen.
- 7) When the camera is set to Playback mode, you can review all the photos and videos stored in the SD memory card on the TV.

Installing the Software

You must be connected to the internet to install and run the Vivitar Experience Image Manager software.

- 1) Insert the installation CD into your CD-ROM drive. The installation screen should automatically open.



- 2) On PC: The Vivitar Experience Image Manager Installer window appears. If the window does not appear, open the application's CD/DVD drive and click on "Setup.exe" to launch the installer.
- 3) On Macintosh: Click the icon that appears on the desktop to install the Vivitar Experience Image Manager.
- 4) If you do not have internet access at the time of inserting the CD-ROM, connect to the internet and then click the "Install Vivitar Experience Image Manager" button to begin the installation.



Note: If you do not have internet access, you can still download media from the camera. Click the "How to transfer photos and videos from my camera to my computer" button for instructions.

- 5) If you have internet access, the “Choose your language” window opens, choose your language and click “Next” to open the next window.
- 6) Select your camera model from the list and click “Next” to open the next window.
- 7) Click “Next” to confirm your camera model selection and to install the application.
- 8) Please wait while the application is being installed on your computer.
- 9) Please review the license terms.

On PC and Macintosh: Click the “I accept the terms of this license agreement” and then click “Next” to continue.

- 10) On PC only: Let the “Vivitar Experience Image Manager” installer create the folder to where the program will be installed, and then click “Install”.

11) Please wait while the application continues the installation process on your computer.

- 12) On PC: Click the “Close” button when the installation is complete.

The application will automatically open.

- 13) On Macintosh: Click the “Close” button when the installation is complete.

Click the “Launch Vivitar Experience Image Manager” to open the application.

- 14) If you close the application you can run the Vivitar Experience Image Manager from the Programs (PC) or Application (Mac) menu on your computer.



Connecting the Camera to the Computer

- 1) Use the supplied USB cable to connect your camera to your computer.
- 2) Power the camera on.
- 3) The first time you connect the device to the computer you will have to wait a few seconds until the computer recognizes the device.

Getting Photos and Videos from Your Camera to Your Computer

An SD card needs to be inserted. Do not disconnect the Built-in USB Connector during transfer. Doing so will cancel the transfer of any files on their way to your computer.

- 1) Select the “Get Images” button from the Main menu.



- 2) The “Get Images from device” window opens.
- 3) You can select to download photos, videos or both.
- 4) Select your camera (removable disk) from the device window. If your camera is the only USB device connected then it will be selected automatically.
- 5) Select a location on the computer where to place the new photo and video files.
- 6) Add the new photo and video files to albums if desired.
- 7) Select to remove the media files from the selected device (removable disk) after the import.
- 8) Click the “Get Images” button to transfer the photos and videos from your camera to your computer.
- 9) A media download progress bar appears on the bottom left showing the number of media files downloading to your computer. A message appears when the download is complete.
- 10) The photo and video files that you selected are now downloaded to your computer to the selected folder and albums ready for your use.

Get started!

Using the Vivitar Experience Image Manager, you can:

- Upload and manage photos and videos to and from the most popular photo sharing and social networking sites - Facebook, Flickr, Picasa, MySpace, Photobucket, Twitpic, Twitgoo and YouTube
- Seamlessly transfer photos and videos from one social network to another
- Organize your images by creating offline and online albums
- Edit images using automatic and manual tools
- Use automatic “Geotagging” with built in Google Maps

For more details on how to use the Vivitar Experience Image Manager open the ‘Help Guide’ from the Help menu or click the “Take a Tour” button on the application’s Home page.

Transferring Images from My Camera to My Computer Manually

Transferring Photos and Videos: WINDOWS

- 1) Use the supplied USB cable to connect your camera to your computer.
- 2) MSDC appears on the LCD.
- 3) A window appears with a list of options, select “Open folder to view files” and click OK.
- 4) Open the DCIM folder and the folder inside to view the media files.
- 5) Select the media and copy the files from this folder into your computer. Optionally, select the files and choose Copy from the Edit menu. Then select a folder and choose Paste from the Edit menu.
- 6) We recommend that you copy the images into the Pictures/My Pictures folder and the videos into the Videos/My Videos folder.
- 7) Do not disconnect the Built-in USB Connector during transfer. Doing so will cancel the transfer of any files on their way to your computer.

Transferring Photos and Videos: MACINTOSH

- 1) Use the supplied USB cable to connect your camera to your computer.
- 2) MSDC appear on the LCD.
- 3) The camera’s device icon appears on the desktop.
- 4) Click on the device icon and open the DCIM folder and the folder inside to view the media files.

- 5) Select the files and drag them into your computer. Optionally, select the files and choose Copy from the Finder's Edit menu. Then select a folder and choose Paste from the Edit menu.
- 6) We recommend that you copy the images into the Pictures folder and the videos into the Movies folder.
- 7) Do not disconnect the USB Built-in Connector during transfer. Doing so will cancel the transfer of any files on their way to your computer.

Transferring Photos and Videos: Apple iPad

NOTE: Please check your device packaging for compatibility with the iPad.

Apple iPad Camera Connection:

For models that are compatible with the iPad, photos and videos can be imported from your digital camcorder to your iPad by following either one of the options below:

1) Connecting your digital camcorder to your iPad using an iPad Camera Connector:

Plug the Camera Connector into the dock connector port on your iPad, then attach your digital camera using a USB cable (included) to the Camera Connector.

NOTE: iPad Camera Connector not included. This may be purchased separately.

2) Using an iPad SD Card Reader:

Connect the SD Card Reader to your iPad, then insert your digital camera's Micro SD Memory card into the slot to import photos and videos directly from your camera's SD card.

NOTE: iPad SD Card Reader not included. This may be purchased separately.

After you make the connection, your iPad automatically opens the Photos application, which allows you choose which photos and videos to import, then organizes them into albums.

Camera Maintenance

The digital video camera is a delicate device. Please handle your digital video camera with care to avoid damaging it.

Do not expose your digital video camera to heat sources.

Do not use you digital video camera in wet or moist conditions.

Sakar Warranty Card

This warranty covers for the original consumer purchaser only and is not transferable. Products that fail to function properly **UNDER NORMAL USAGE**, due to defects in material or workmanship will be repaired at no charge for parts or labor for a period of one year.

What Is Not Covered By Warranty:

Damages or malfunctions not resulting from defects in material or workmanship and damages or malfunctions from other than normal use, including but not limited to, repair by unauthorized parties, tampering, modification or accident.

What To Do When Service Is Required:

When returning your defective product (postage pre-paid) for service, your package should include:

- 1) Copy of **original** bill of sale
- 2) A detailed written description of the problem.
- 3) Your return address and telephone number (Daytime)

MAIL TO ADDRESS BELOW:

<u>Sakar US</u>	<u>Sakar UK/Europe</u>	<u>Sakar Australia</u>
Sakar International Attention: Service Department 195 Carter Drive Edison, NJ 08817	Attention: Service Department 2D, Siskin Parkway East 4020 Middlemarch Business Park Coventry, CV3 4PE	Return faulty camera to the Refund Counter at the store where purchased

Technical Support

For technical support issues please visit our website at www.vivitar.com. You can find manuals, software and FAQ's at the website. Can't find what you are looking for? E-mail us at support@vivitar.com and one of our technical support team members will answer your questions. For phone support in the US please call 1-800-592-9541, in the UK call 0800 917 4831, in Australia call 1800-006-614. If you would like to call from anywhere else, please visit www.vivitar.com for your local toll free number.

Troubleshooting

Q: I have taken photos and selected the “Get Images” button. I get a message that the images were successfully transferred but the photos do not appear on my computer. What do I do?

First ensure that you have in fact taken photos. Press the Shutter button to take some sample photos and then try downloading them again.

With test photos if the camera powers off before you upload them to the computer the photos are not stored in the camera's memory. These photos should be uploaded quickly before the camera powers off.

If the photos are saved to the SD memory card then all the photos should appear.

Q: How do I make sure I don't lose important pictures?

This camera requires an SD card for normal use. If the camera powers off nothing will happen to the images stored on the SD memory card. We recommend always downloading your photos to your computer as soon as possible to prevent unintentional data loss.

Q: I deleted images using the Vivitar Experience Image Manager. The images were also deleted from my computer. How do I recover images that I accidentally deleted?

All images deleted using the Vivitar Experience Image Manager are sent to your computer's Recycle or Trash Bin and can be retrieved from there.

DVR1020HD_2-111511-TA